

# CTHRD Pivot Slide

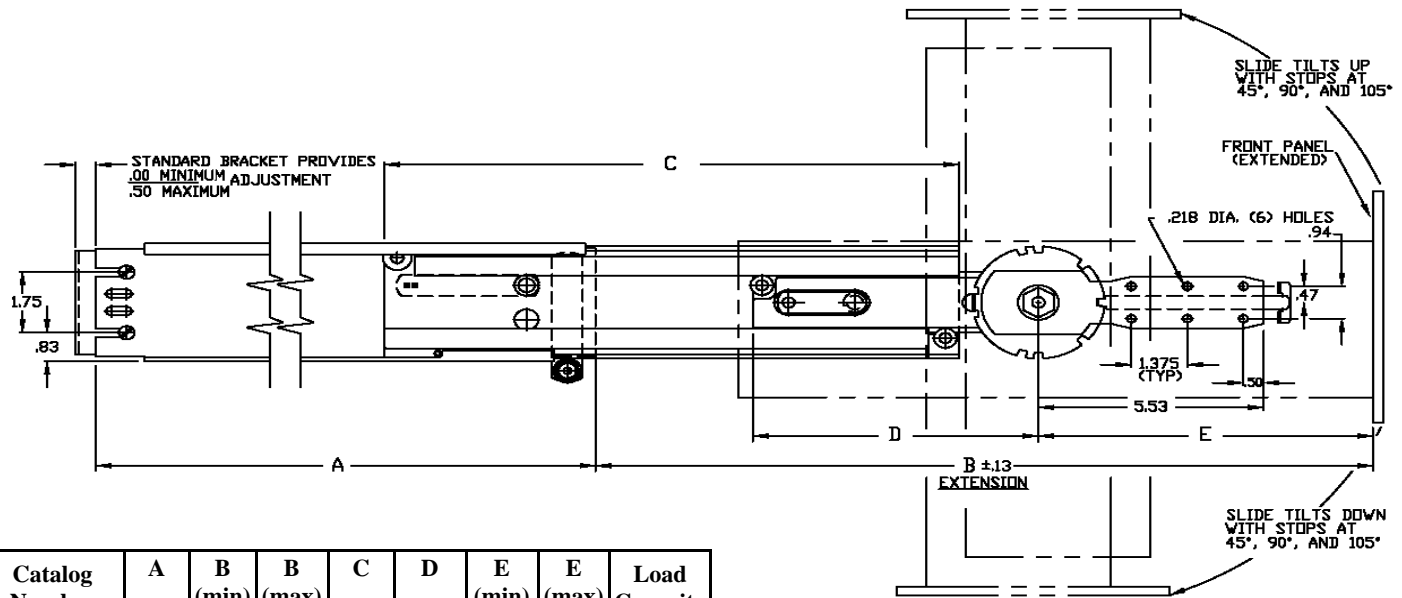
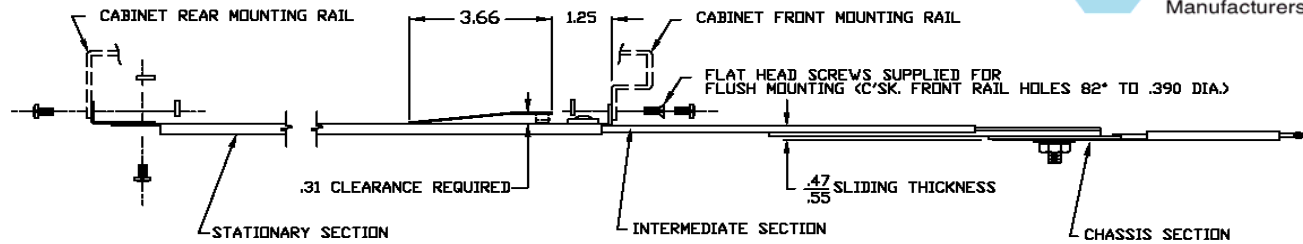

Catalog Number	A	B (min)	B (max)	C	D	E (min)	E (max)	Load Capacity
CTHRD-114	14.00	15.13	15.63	13.00	7.00	6.50	7.00	275 LBS.
CTHRD-116	16.00	19.00	19.63	15.00	8.88	6.50	7.13	275 LBS.
CTHRD-118	18.00	21.00	23.63	17.00	8.88	6.50	9.13	275 LBS.
CTHRD-120	20.00	23.00	27.63	19.00	8.88	6.50	11.13	275 LBS.
CTHRD-122	22.00	23.88	29.63	21.00	9.75	6.50	12.25	275 LBS.
CTHRD-124	24.00	24.25	31.63	23.00	9.75	6.88	14.25	275 LBS.

## TO ORDER, SPECIFY

CTHRD -  -  -

Stationary Section  
1 - Cabinet Mount  
2 - Strap Mount  
4 - Closed Slot

Length

AR - Automatic Release if desired

For information on Strap Mount option see page 28.

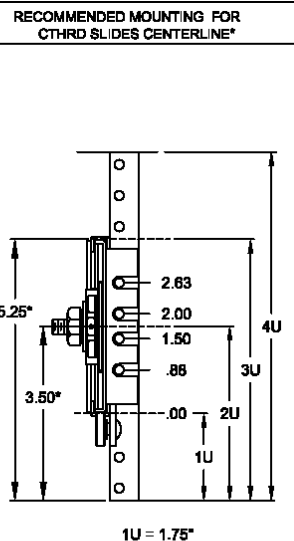
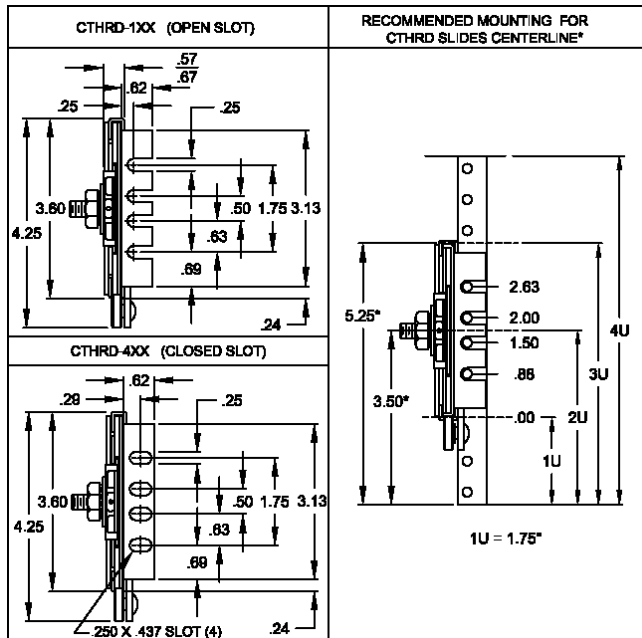

## Notes

- Right hand shown, left hand opposite.
- Finish: All standard slides are coated with Poxylube™ dry film lubricant.
- All standard slides are designed to lock-out in the extended position and are available with an optional automatic release if lock-out is not desirable.
- Standard hardware packages include all the hardware necessary to mount your Chassis Trak® slides:
  - Rear mounting bracket (B-131) included
  - Bar Nuts (CA8056-06-0020)
  - #10-32 screws and keps nuts
- All sliding members of the standard slide are made from cold rolled steel.
- All Chassis Trak® solid bearing slides are supplied with a quick disconnect feature.
- Optional mounting patterns, slide lengths and extensions are available.
- Pickup tab available for units without a front panel.
- See safety recommendations for detent slides on page 9.
- For optional mounting brackets see pages 35.

# Strap Mounting Option

## CTRS Strap Mount

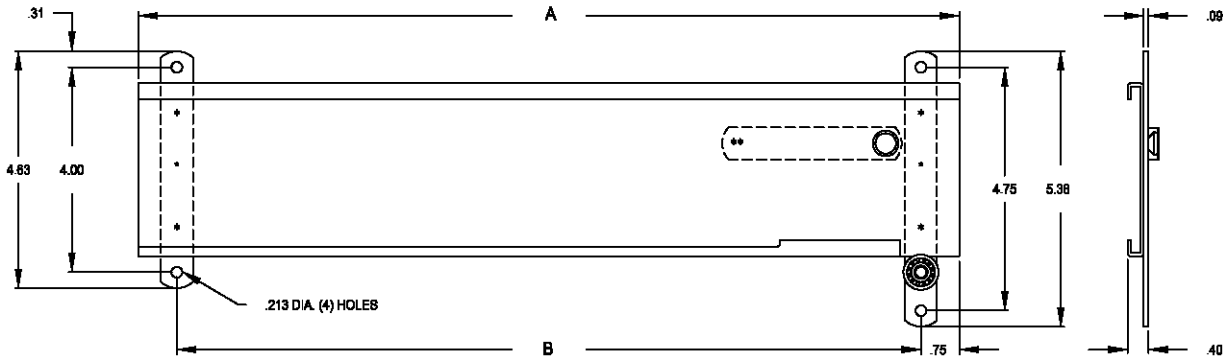

A	B
12.00	10.50
14.00	12.50
16.00	14.50
18.00	16.50
20.00	18.50
22.00	20.50
24.00	22.50

### Notes

1. To order, specify **CTRS-2[XX]** see pages 20-21 for more information.
2. Strap mount slides are not designed to accommodate the standard EIA hole pattern.
3. All slides requires a .31" clearance behind the spring and button assembly for proper operation.

## CTHS Strap Mount

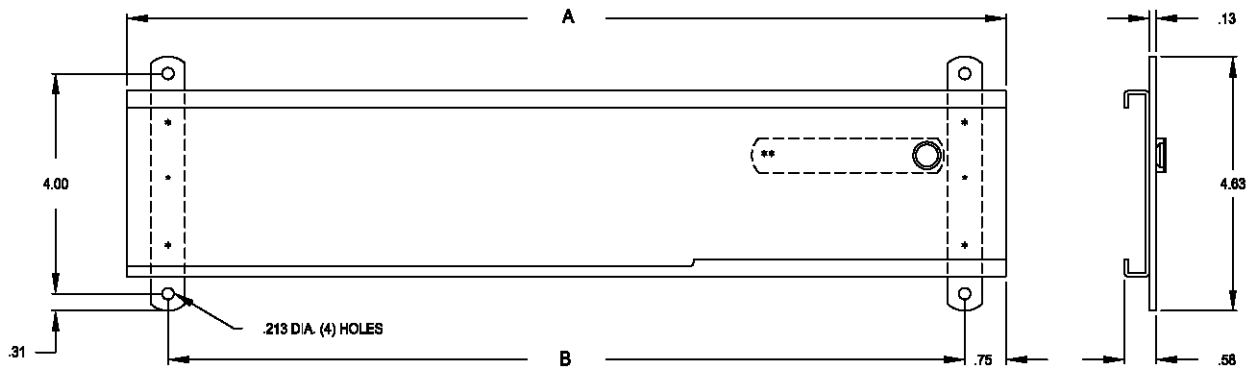

A	B
12.00	10.50
14.00	12.50
16.00	14.50
18.00	16.50
20.00	18.50
22.00	20.50
24.00	22.50

### Notes

1. To order, specify **CTHS-2[XX]** see pages 22-23 for more information.
2. Strap mount slides are not designed to accommodate the standard EIA hole pattern.
3. All slides requires a .31" clearance behind the spring and button assembly for proper operation.

## CTHRS Strap Mount

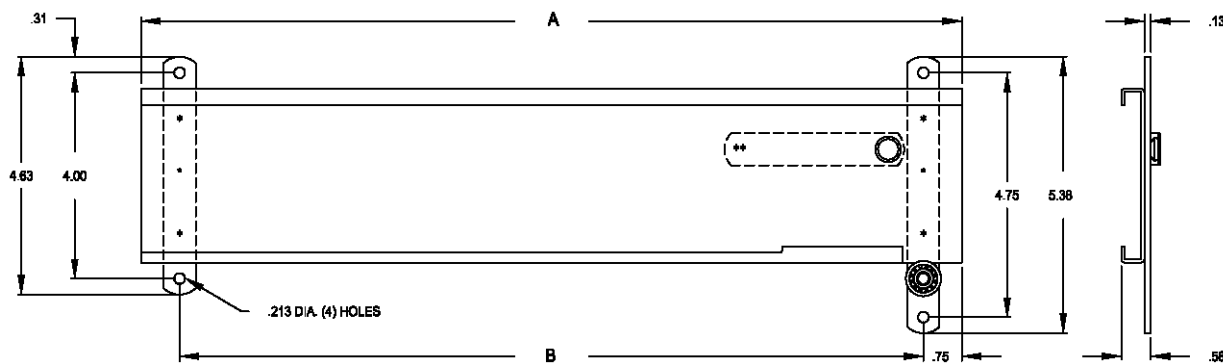

A	B
12.00	10.50
14.00	12.50
16.00	14.50
18.00	16.50
20.00	18.50
22.00	20.50
24.00	22.50

### Notes

1. To order, specify **CTHRS-2[XX]** see pages 24-25 for more information.
2. Strap mount slides are not designed to accommodate the standard EIA hole pattern.
3. All slides requires a .31" clearance behind the spring and button assembly for proper operation.

# Optional Mounting Brackets



Matrix For Solid Bearing Slides & Appropriate Rear Mounting Brackets with Range of Extension										
	B-131*	B-131-2	B-131-2.5	B-131-3	B-131-3.5	B-131-4	B-307-1 B-814-1	B-307-2 B-814-2	B-810-1	B-810-2
C-230-D	0 to .50	.44 to 1.06	.94 to 1.56	1.44 to 2.06	1.94 to 2.56	2.44 to 3.06	0 to 4.00	0 to 8.00		
C-230-S	0 to .50	.44 to 1.06	.94 to 1.56	1.44 to 2.06	1.94 to 2.56	2.44 to 3.06	0 to 4.00	0 to 8.00		
CTD	0 to .50	.44 to 1.06	.94 to 1.56	1.44 to 2.06	1.94 to 2.56	2.44 to 3.06	0 to 4.00	0 to 8.00		
CTS	0 to .50	.44 to 1.06	.94 to 1.56	1.44 to 2.06	1.94 to 2.56	2.44 to 3.06	0 to 4.00	0 to 8.00		
CTR D	0 to .50	.44 to 1.06	.94 to 1.56	1.44 to 2.06	1.94 to 2.56	2.44 to 3.06	0 to 4.00	0 to 8.00		
CTR S	0 to .50	.44 to 1.06	.94 to 1.56	1.44 to 2.06	1.94 to 2.56	2.44 to 3.06	0 to 4.00	0 to 8.00		
CTHD	0 to .50	.44 to 1.06	.94 to 1.56	1.44 to 2.06	1.94 to 2.56	2.44 to 3.06			0 to 4.00	0 to 8.00
CTHS	0 to .50	.44 to 1.06	.94 to 1.56	1.44 to 2.06	1.94 to 2.56	2.44 to 3.06			0 to 4.00	0 to 8.00
CTHR D	0 to .50	.44 to 1.06	.94 to 1.56	1.44 to 2.06	1.94 to 2.56	2.44 to 3.06			0 to 4.00	0 to 8.00
CTHR S	0 to .50	.44 to 1.06	.94 to 1.56	1.44 to 2.06	1.94 to 2.56	2.44 to 3.06			0 to 4.00	0 to 8.00
C-857	0 to .50	.44 to 1.06	.94 to 1.56	1.44 to 2.06	1.94 to 2.56	2.44 to 3.06				

Note brackets are made from 16 gauge C.R.S. — Standard finish: clear zinc commercial plating

\*Supplied with standard slides

CATALOG NUMBER	A
B-131	1.56
B-131-2	2.00
B-131-2.5	2.50
B-131-3	3.00
B-131-3.5	3.50
B-131-4	4.00

CATALOG NUMBER	A	B	C
B-307-1 / B-810-1 / B-814-1	5.94	4.38	16
B-307-2 / B-810-2 / B-814-2	9.69	8.13	28